

ELECTRICAL

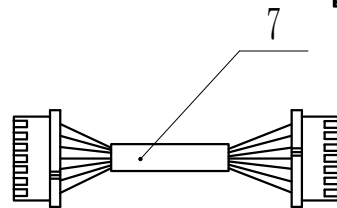
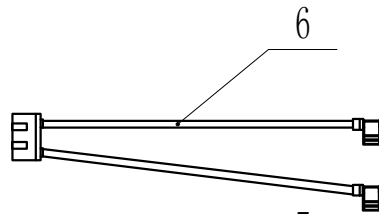
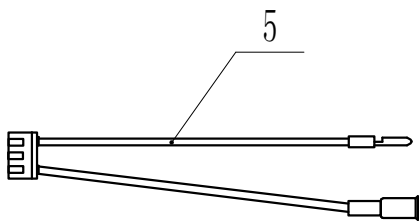
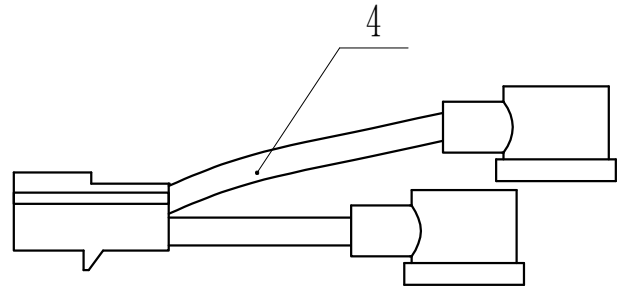
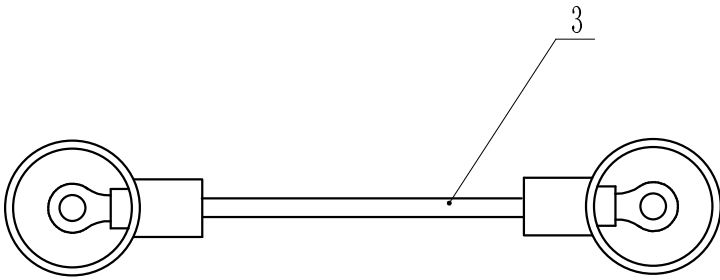
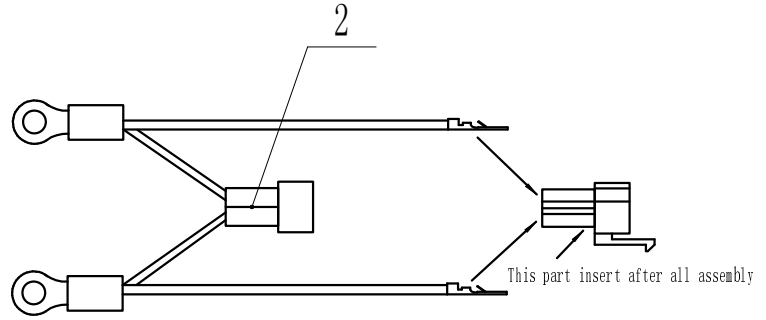
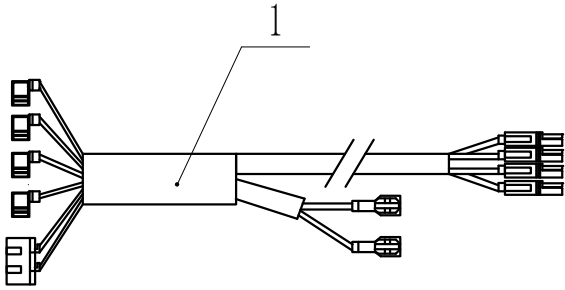

ELECTRICAL PARTS - FANG 15B - LIST PRICE (U.S.A.)

Item	Part No.	Description	Qty		List Price
1	VF89026	MOTOR WIRE	1		\$24.50
2	VF89022	MAIN POWER WIRE	1		\$12.13
3	VF89021	BATTERY CONNECT WIRE	1		\$13.25
4	VF89036	POWER WIRE	1		\$17.90
5	VF89024	CHARGER INPUT WIRE	1		\$1.35
6	VF89620	KIT, 4-LEG SWITCH	1		\$5.75
7	VF89025-3	COMMUNICATION WIRE	1		\$11.08

*PRICING IS FOR USA ONLY. CANADIAN CUSTOMERS PLEASE CALL 800-668-8400...OPTION #2