



- Model 5262 — Single Roll
- Model 5263 — Double Roll **Bradex**[®]
- Dispenser with Shelf

Product Materials

SHELF: 18 gauge stainless steel with exposed surfaces in architectural satin finish. Front and side edges are 1/2". Radius on all corners.

TISSUE DISPENSER: 18 gauge stainless steel with exposed surfaces in architectural satin finish. Spindle(s) of ABS plastic with concealed spring.

Capacity

One (two) standard core 6" diameter toilet tissue roll(s).

Operation

Spindle(s) easily removed for servicing.

Installation

Verify all rough-in dimensions prior to installation. Secure dispenser with mounting screws (included) at holes provided.

Optional Features

Feature	Suffix
<input type="checkbox"/> Anti-theft spindle	-52

Guide Specification

Model 5262: Toilet tissue dispenser with shelf shall be fabricated of 18 gauge stainless steel with exposed surfaces in architectural satin finish. Tissue dispenser to hold one standard core toilet tissue roll.

Model 5263: Toilet tissue dispenser with shelf shall be fabricated of 18 gauge stainless steel with exposed surfaces in architectural satin finish. Tissue dispenser to hold two standard core toilet tissue rolls.

Overall dimensions: 16"W x 3 1/16"H x 6"D.



Model 5262

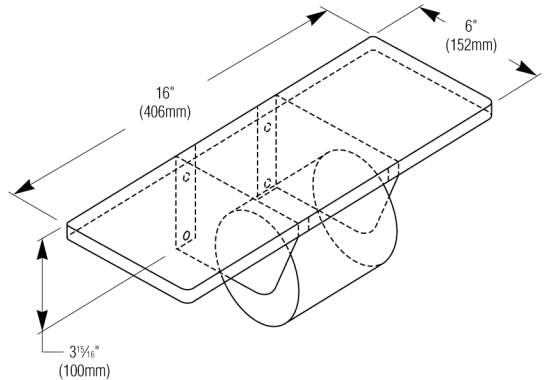

Model 5263

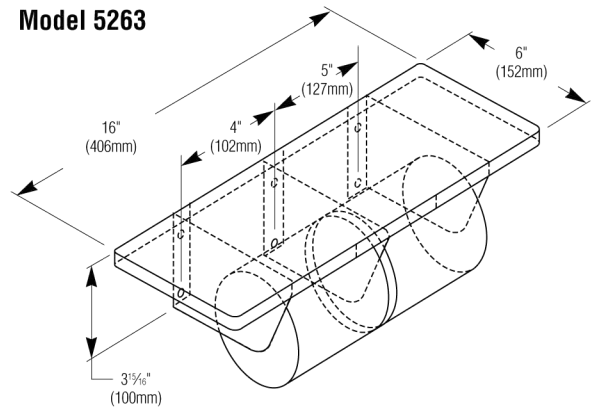

Orders composed of products indicated as **Bradex**[®] will be available to ship in three days after receipt of order at the factory. There is no pricing penalty for this service from Bradley.